

PREPARED BY : DATE
L.YOU : Aug.08.2014
T.UMEHARA : Aug.08.2014

CHECKED BY : DATE
X.HAN : Aug.08.2014
Y.YAMAGUCHI : Aug.08.2014

SHARP

DISPLAY DEVICE BUSINESS
SHARP CORPORATION

SPECIFICATION

SPEC No. LCY-W14701
FILE No.
ISSUE : Aug.08.2014
PAGE : 26 pages

SHARP (CHINA) INVESTMENT
CO.,LTD

Device Specification for

TFT-LCD module

MODEL No. **LQ133M1JW07**

CUSTOMER'S APPROVAL

DATE _____

BY _____

PRESENTED

BY *T. Itoh*

T.Itoh
DEPARTMENT GENERAL MANAGER
DEVELOPMENT DEPARTMENT
DISPLAY DEVICE UNIT II
DISPLAY DEVICE BUSINESS DIVISION

BY *T. Yamamoto*

T. Yamamoto
DEPARTMENT GENERAL MANAGER
DEVELOPMENT DIVISION II
DESIGN CENTER NO.2
DISPLAY DEVICE GROUP
SHARP (CHINA) INVESTMENT CO.,LTD

NOTICE

This publication is the proprietary of SHARP and is copyrighted, with all rights reserved. Under the copyright laws, no part of this technical literature may be reproduced or transmitted in any form or by any means, electronic or mechanical for any purpose, in whole or in part, without the express written permission of SHARP. Express written permission is also required before any use of this publication may be made by a third party.

The application circuit examples in this technical literature are provided to explain the representative applications of SHARP's devices and are not intended to guarantee any circuit design or permit any industrial property right or other rights to be executed. SHARP takes no responsibility for any problems related to any industrial property right or a third party resulting from the use of SHARP's devices, except for those resulting directly from device manufacturing processes.

In the absence of confirmation by device specification sheets, SHARP takes no responsibility for any defects that occur in equipment using any of SHARP's devices, shown in catalogs, data books, etc. Contact SHARP in order to obtain the latest device specification sheets before using any SHARP's device.

SHARP reserves the right to make changes in the specifications, characteristics, data, materials, structures and other contents described herein at any time without notice in order to improve design or reliability. Contact SHARP in order to obtain the latest specification sheets before using any SHARP's device. Manufacturing locations are also subject to change without notice.

Observe the following points when using any device in this technical literature. SHARP takes no responsibility for damage caused by improper use of the devices.

The devices in this technical literature are designed for general electronic equipment use.

The appropriate design measures should be taken to ensure reliability and safety when SHARP's devices are used for equipment such as:

- Transportation control and safety equipment(i.e., aircraft, trains, automobiles, etc.)
- Traffic signals • Gas leakage sensor breakers • Alarm equipment • Various safety devices etc.

SHARP's devices shall not be used for equipment that requires extremely high level of reliability, such as:

- Military and space applications • Nuclear power control equipment
- Medical equipment for life support

Contact a SHARP representative, in advance, when intending to use SHARP's devices for any "specific" applications other than those recommended by SHARP.

Contact and consult with a SHARP representative if there are any questions about the contents of this publication.

Table of contents

1. Application.....	3
2. Overview.....	3
3. Mechanical Specifications	3
4. Input Terminals.....	4
4 - 1. Symbol.....	4
4 - 2. eDP interface.....	6
5. Absolute Maximum Ratings	7
6. Electrical Characteristics	8
6-1. TFT-LCD panel driving.....	8
6-2. Backlight driving	11
7. Timing Characteristics of Input Signals.....	12
7-1. Timing characteristics	12
7-2. Input data signals and display position on the screen	13
8. Input Signals, Basic Display Colors and Gray Scale of Each Color.....	14
9. EDID Specifications	15
9 - 1. EDID data structure	15
10. Optical Characteristics	18
11. Display Quality	19
12. Handling Precautions	20
13. Precautions for Handling Tray	21
14. Packaging Condition.....	22
15. Label	23
16. RoHS Directive.....	23
17. Reliability Test Items.....	24
Fig. 1 Packaging Condition.....	25
Fig. 2 Outline Dimensions	26

1. Application

This specification applies to a color TFT-LCD Module, LQ133M1JW07.

2. Overview

This module is a color active matrix LCD module incorporating Oxide TFT (Thin Film Transistor). It is composed of a color TFT-LCD panel, driver ICs, a control circuit and power supply circuit and a backlight unit. Graphics and texts can be displayed on a 1920×3×1080 dots panel with 16,777,216 colors by using eDP (Embedded Display Port) interface and supplying +3.3V DC supply voltage for TFT-LCD panel driving.

In this TFT-LCD panel, color filters for excellent color performance is incorporated to realize brighter and clearer pictures, making this model optimum for use in multi-media applications.

Optimum viewings are in all directions.

7 serial 8 parallel LED structure.

Backlight-driving LED controller is built in this Module

eDP Transfer rate Specification : eDP1.2 / 2.7Gbps / 2 lane

3. Mechanical Specifications

Parameter	Specifications	Unit
Display size	33.70 (13.3") Diagonal	cm
Active area	293.76(H)×165.24 (V)	mm
Pixel format	1920 (H)×1080 (V)	pixel
	(1 pixel = R+G+B dots)	
Pixel pitch	0.153 (H) × 0.153 (V)	mm
Pixel configuration	R,G,B vertical stripe	
Display mode	Normally black	
Surface treatment of front polarizer	Anti-glare coating (3H)	

Outline dimensions

Parameter		Min.	Typ.	Max.	Unit	Remark
Unit outline dimensions [Note 3-1]	Width	305.05	305.35	305.65	mm	
	Height	187.36	187.86	188.36	mm	w/ PWB and tape
		177.81	178.11	178.41	mm	w/o PWB
	Depth	-	-	3.00	mm	[Note3-2]
Mass		-	270	290	g	

[Note 3-1] Outline dimensions is shown in Fig.2

[Note 3-2] With shading tape, without warpage and deflection.

4. Input Terminals

4 - 1. Symbol

CN1 (eDP signals, +3.3V DC power supply, and B/L power supply)

Pin No.	Symbol	I/O	Function	Remark
1	NC	-	Reserved for LCD	[Note4-1-1]
2	H_GND	P	High Speed Ground	
3	Lane1_N	I	Complement Signal Link Lane 1	
4	Lane1_P	I	True Signal Link Lane 1	
5	H_GND	P	High Speed Ground	
6	Lane0_N	I	Complement Signal Link Lane 0	
7	Lane0_P	I	True Signal Link Lane 0	
8	H_GND	P	High Speed Ground	
9	AUX_CH_P	I	True Signal Auxiliary Channel	
10	AUX_CH_N	I	Complement Signal Auxiliary Channel	
11	H_GND	P	High Speed Ground	
12	LCD_VCC	P	LCD logic and driver power(3.3V)	
13	LCD_VCC	P	LCD logic and driver power(3.3V)	
14	NC	I	Reserved for LCD manufacturer's use	[Note 4-1-1]
15	LCD_GND	P	LCD logic and driver ground	
16	LCD_GND	P	LCD logic and driver ground	
17	HPD	O	HPD signal pin	[Note 4-1-2]
18	BL_GND	P	Backlight ground	
19	BL_GND	P	Backlight ground	
20	BL_GND	P	Backlight ground	
21	BL_GND	P	Backlight ground	
22	BL_ENABLE	I	Backlight On/Off	[Note 4-1-3]
23	BL_PWM_DIM	I	System PWM	[Note 4-1-4]
24	NC	-	Reserved for LCD manufacturer's use	[Note4-1-1]
25	NC	-	Reserved for LCD manufacturer's use	[Note4-1-1]
26	BL_PWR	P	Backlight power	
27	BL_PWR	P	Backlight power	
28	BL_PWR	P	Backlight power	
29	BL_PWR	P	Backlight power	
30	NC	-	Reserved for LCD manufacturer's use	[Note4-1-1]

*1 P : Power , I : Input , O : Output

[Note 4-1-1] Do not input any signals or any powers into a NC pin. Keep the NC pin open.

- Connector used :20455-030E-12 (I-PEX)
- Corresponding connector : 20453-030T (I-PEX)

(Sharp is not responsible to its product quality, if the user applies a connector not corresponding to the above model.)

[Note 4-1-2] Output circuit is as below.

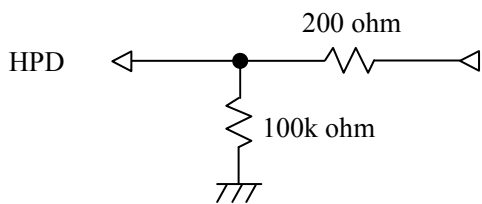

[Note 4-1-3] Input circuit is as below.

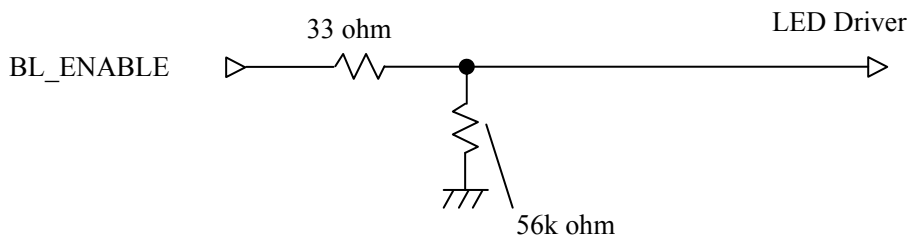

[Note 4-1-4] Input circuit is as below.

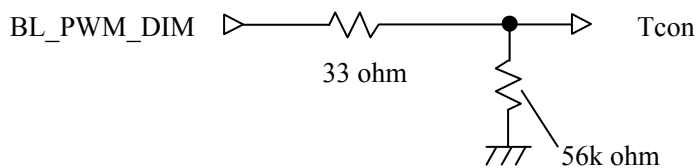

[Note 4-1-5] All terminals except NC terminal must be connected to input signal described as above or supply voltage or GND each.

4 - 2. eDP interface

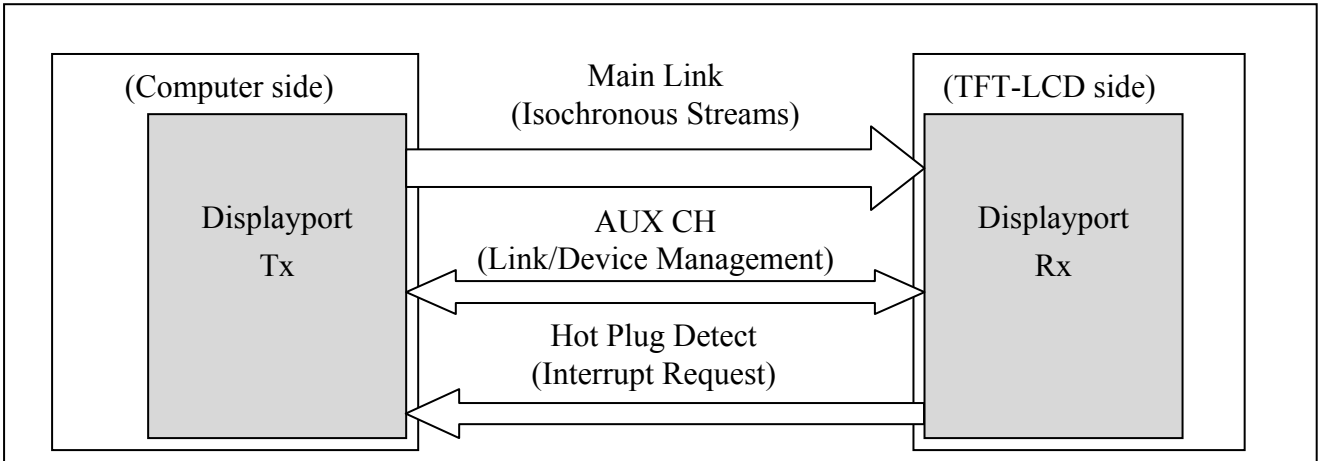

Fig.4-2-1 DP architecture.

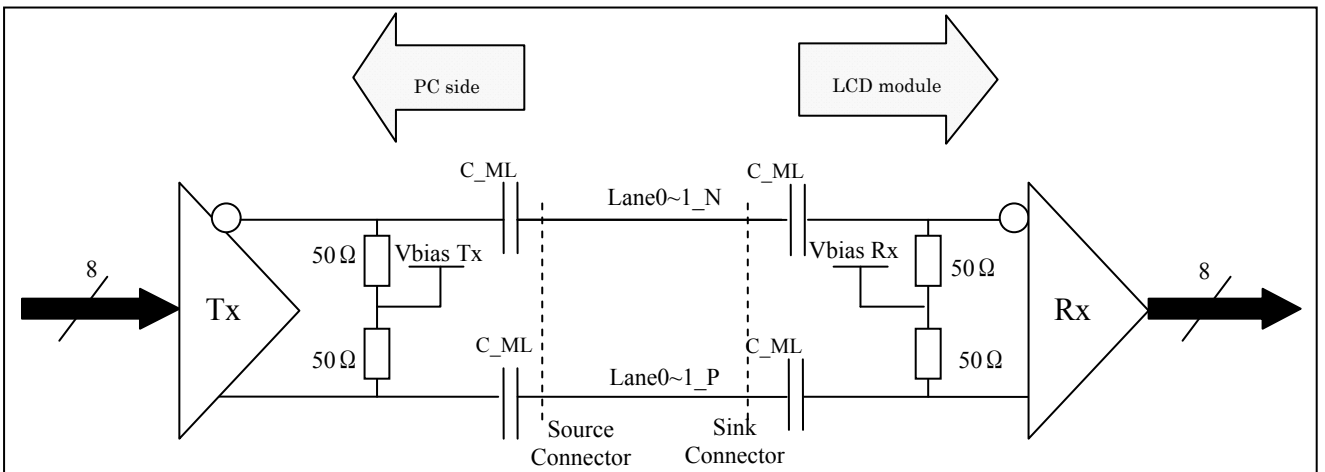

Fig.4-2-2 Main Link differential pair.

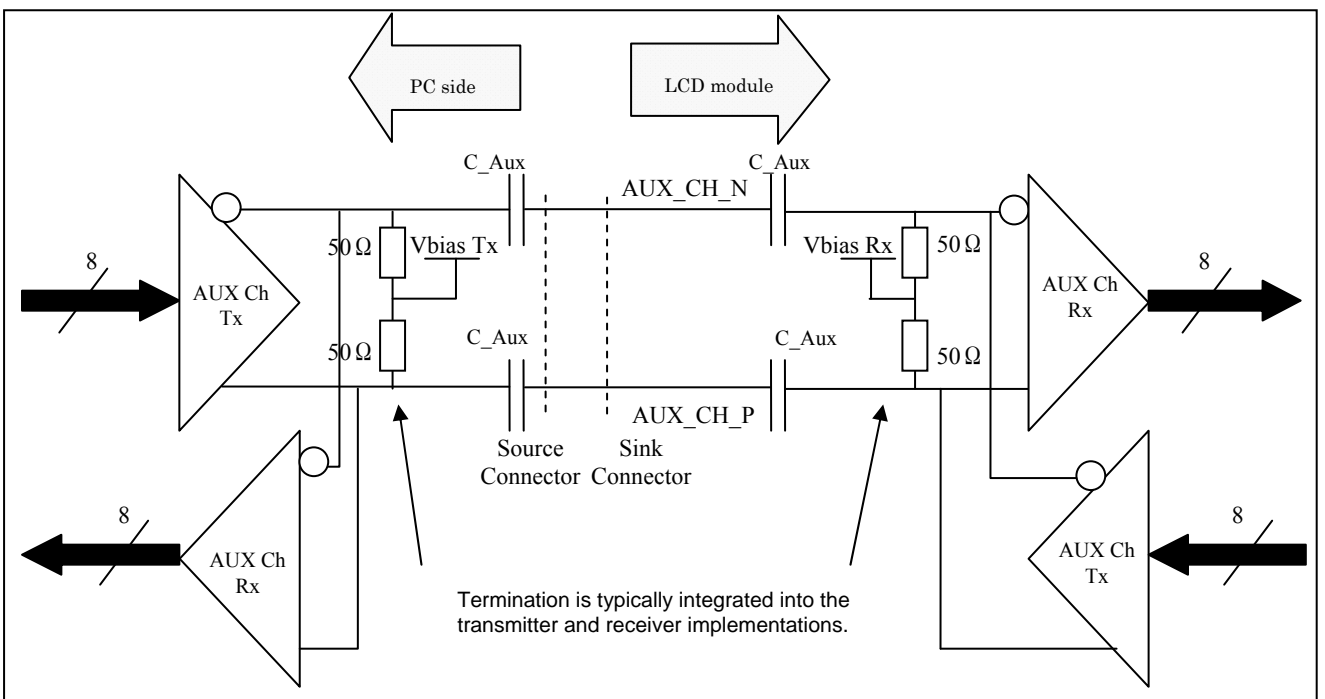

Fig.4-2-3 AUX Link differential pair.

Lane0	Lane1
R0-7:0	R1-7:0
G0-7:0	G1-7:0
B0-7:0	B1-7:0
R2-7:0	R3-7:0
G2-7:0	G3-7:0
B2-7:0	B3-7:0
R4-7:0	R5-7:0
G4-7:0	G5-7:0
B4-7:0	B5-7:0

Fig.4-2-4 eDP 2 lane 8 bit input data mapping.

5. Absolute Maximum Ratings

Parameter	Symbol	Condition	Ratings		Unit	Remark
			Min.	Max.		
+3.3V supply voltage	VDD	Ta=25°C	-0.3	+4.0	V	
Back Light supply voltage	VBL	Ta=25°C	-0.3	+26.5	V	
Input voltage(eDP)	VI	Ta=25°C	-0.3	+1.5	V	[Note 5-1]
Input voltage(BL)	VBL_I	Ta=25°C	-0.3	VDD+0.3	V	[Note 5-2]
Storage temperature (ambient)	Tstg	—	-20	+60	°C	[Note 5-3]
Operating temperature(ambient)	Topa	—	0	+50	°C	

[Note 5-1] eDP signals

[Note 5-2] Back light control signals (BL_ENABLE, BL_PWM_DIM)

[Note 5-3] Humidity : 90%RH Max. at Ta ≤ +40°C.

Maximum wet-bulb temperature at +39°C or less at Ta > +40°C.

No condensation.

6. Electrical Characteristics

6 - 1. TFT-LCD panel driving

T_a = +25°C

DC Electrical Characteristics						
Parameter	Symbol	Min.	Typ.	Max.	Unit	Remark
Supply voltage	VDD	+3.0	+3.3	+3.6	V	[Note 6-1-1]
Current dissipation	IDD	—	180	300	mA	[Note 6-1-4]
Permissive input ripple voltage	V _{RP}	—	—	100	mV _{P-P}	VDD = +3.3V
eDP HPD Signal Characteristics						
Parameter	Symbol	Min.	Typ.	Max.	Unit	Remark
HPD High level output voltage	VOH _{HPD}	2.0	2.5	-	V	
HPD Low level output voltage	VOL _{HPD}	-	0	0.5	V	
eDP AUX Channel Characteristics						
Parameter	Symbol	Min.	Typ.	Max.	Unit	Remark
Unit Interval for AUX channel	UI _{AUX}	0.4	0.5	0.6	μs	
peak-to-peak voltage at TP1	V _{AUX-DIFF-pp}	0.32	-	1.36	V	
AUX DC Common Mode Voltage	V _{AUX-DC-CM}	0	-	2.0	V	
AUX Short Circuit Current Limit	I _{AUX_SHORT}	-	-	90	mA	
AUX CH termination DC resistance	R _{AUX_TERM}	-	100	-	Ω	
AUX AC Coupling Capacitor	C _{AUX}	75	-	200	nF	
Number of pre-charge pulses	Pre-charge pulses	10	-	16	-	
eDP Main Link Receiver Characteristics						
Parameter	Symbol	Min.	Typ.	Max.	Unit	Remark
Link clock down spreading	Down_Spread_Amplitude	0		0.5	%	
Differential Peak-to-peak Input Voltage at RX package pins	V _{RX-DIFFp-p}	120	-	1200	mV	
Differential Return Loss at 1.35 GHz at RX package pins	RL _{RX-DIFF}	9	-	-	dB	
Differential termination resistance	V _{RX-TERM}	-	100	-	Ω	
RX Short Circuit Current Limit	I _{RX-SHORT}	-	-	50	mA	
Lane Intra-pair Skew at RX package pins	L _{RX-SKEW-INTRA-PAIR-High-Bit-Rate}	-	-	50	ps	

[Note 6-1-1] ON-OFF conditions for supply voltage

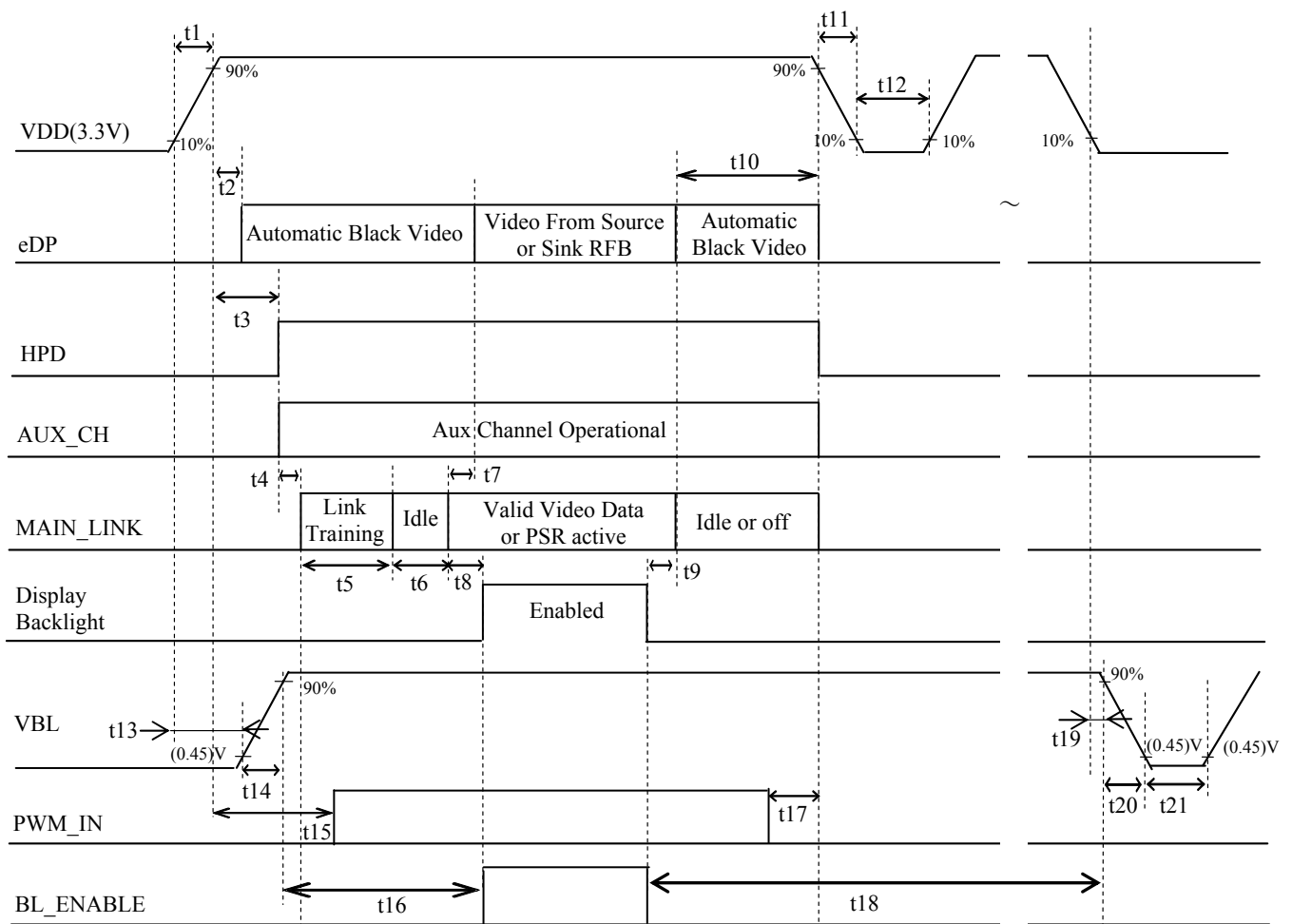

[Note 6-1-2] Do not keep the interface signal high-impedance or unusual signal when power is on.

Symbol	Min	Max	Unit	Note
t1	0.5	10	ms	
t2	0	200	ms	
t3	0	100	ms	
t4	—	—	ms	
t5	—	—	ms	
t6	—	—	ms	
t7	0	50	ms	
t8	—	—	ms	
t9	—	—	ms	
t10	0	500	ms	
t11	1	50	ms	[Note 6-1-3]
t12	500	—	ms	
t13	-	-	ms	
t14	0.5	10	ms	

t15	100		ms	
t16	0	-	ms	
t17	0	-	ms	
t18		-		
t19	-	-	ms	
t20	0.1	-	ms	
t21	100		ms	

[Note 6-1-3]

As for the power off sequence for VDD (t11), Be sure to keep above mentioned timing.

If the VDD power off sequence timing is other than shown above, LCD may cause permanent damage.

*1 : As for the power sequence for backlight, it is recommended to apply above mentioned input timing.

If the backlight is light on and off at a timing other than shown above, displaying image may get disturbed.

VDD-dip conditions

1) $2.5\text{ V} \leq \text{VDD} < 3.0\text{ V}$

$t_d \leq 10\text{ ms}$

Under above condition, the display image should return to an appropriate figure after VDD voltage recovers.

2) $\text{VDD} < 2.5\text{ V}$

VDD-dip conditions should also follow the ON-OFF conditions for supply voltage

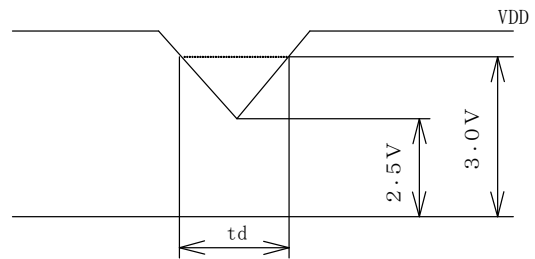

[Note 6-1-4] Typical current condition: 16-gray-bar pattern.

VDD=+3.3V

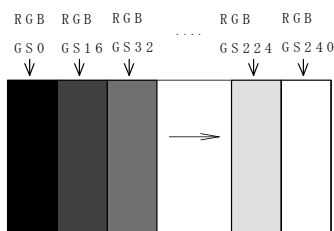

Maximum current condition: Vertical stripe pattern

VDD=+3.3V

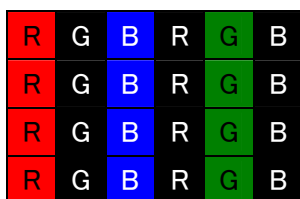

6 - 2. Backlight driving

The backlight system is an edge-lighting type with white-LED.

(It is usually required to measure under the following condition. : Ta=25°C ±2°C)

Parameter	Symbol	Min.	Typ.	Max	Unit	Remark
Supply voltage	V _{BL}	7.0	12.0	21.0	V	
Current dissipation	I _{BL}	—	300	540	mA	V _{BL} = 12.0V(Typ) V _{BL} = 7.0V(Max) Duty Ratio=100%
Modulated light signal voltage	V _{PWMH}	1.85	—	VDD	V	
	V _{PWML}	0	—	0.7	V	
Brightness Control Duty Ratio	Duty	1	—	100	%	【Note6-2-1】
Brightness Control pulse width	T _{PWM}	5	—	—	us	【Note6-2-2】
Brightness Control frequency	f _{PWM}	200	—	2,000	Hz	
LED-BL ON/OFF High voltage	V _{CNTH}	1.3	—	VDD	V	【Note6-2-3】
LED-BL ON/OFF Low voltage	V _{CNTL}	0	—	0.5	V	
Input signal pin current	I _{IN}	—	V _{IN} /56KΩ	—	μA	BL_ENABLE, BL_PWM_DIM
LED lifetime	-	—	10,000	—	h	LED

【Note6-2-1】 V_{PWM} Input : 100%= Max luminance 1%= Min luminance

【Note6-2-2】 The minimum value of the dimming signal pulse width is assumed regulations of the width of high and the width of low.

【Note6-2-3】 V_{CNT} Input : High = BL turn on, Low or OPEN =BL turn off

V_{BL}-dip conditions

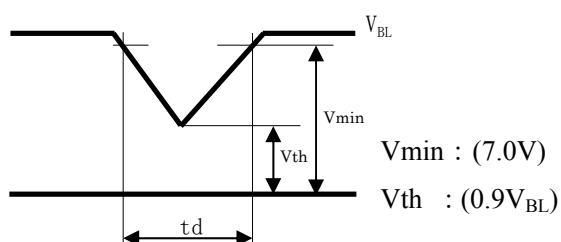

1) $V_{th} \leq V_{BL} < V_{min} : t_d \leq 20ms$

2) $V_{BL} < V_{th}$: The condition of instantaneous voltage drop is apply to input voltage sequences

7. Timing Characteristics of Input Signals

7-1. Timing characteristics

VDD=+3.0V~+3.6V, Ta=0°C~+50°C

Parameter		Symbol	Min.	Typ.	Max.	Unit	Remark
Clock	Frequency	1/Tc	—	138.5	—	MHz	[Note 7-1-1]
Data enable Signal	Horizontal period	TH	—	2080	—	clock	
			—	15.02	—	μs	
	Horizontal period (High)	THd	—	1920	—	clock	
	Vertical period	TV	—	1111	—	line	
			—	16.685	—	ms	
Vertical period (High)	TVd	—	1080	—	line		

[Note 7-1-1] In case of using the long vertical period, the deterioration of display quality, flicker, etc, may occur.

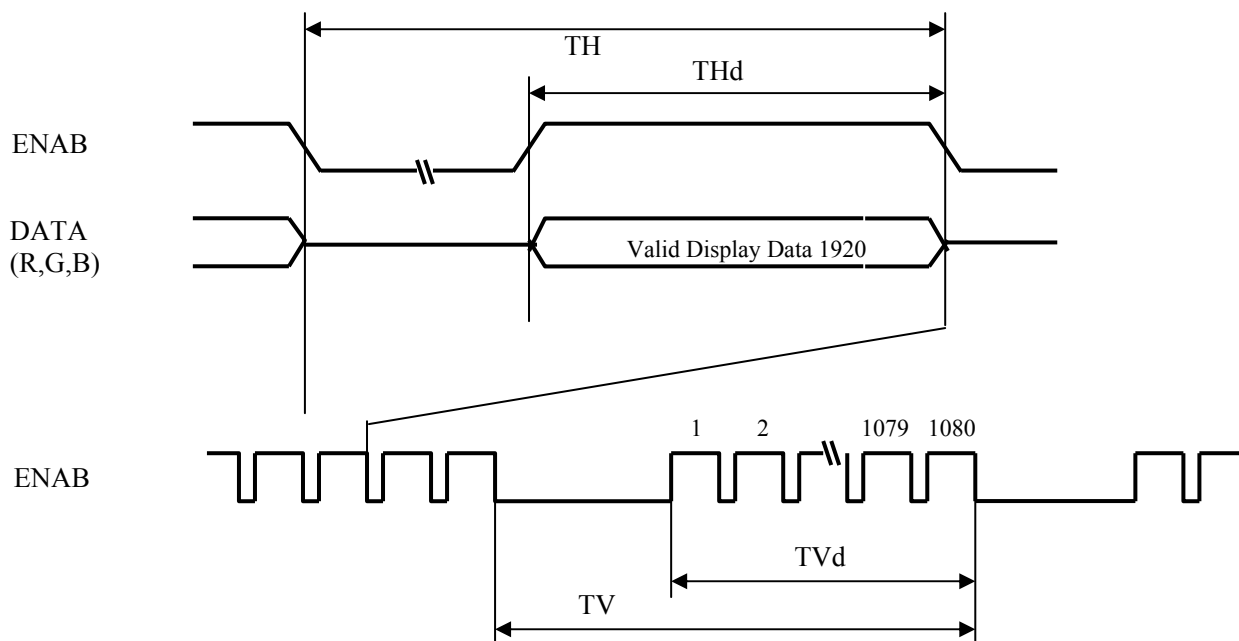

7-2. Input data signals and display position on the screen

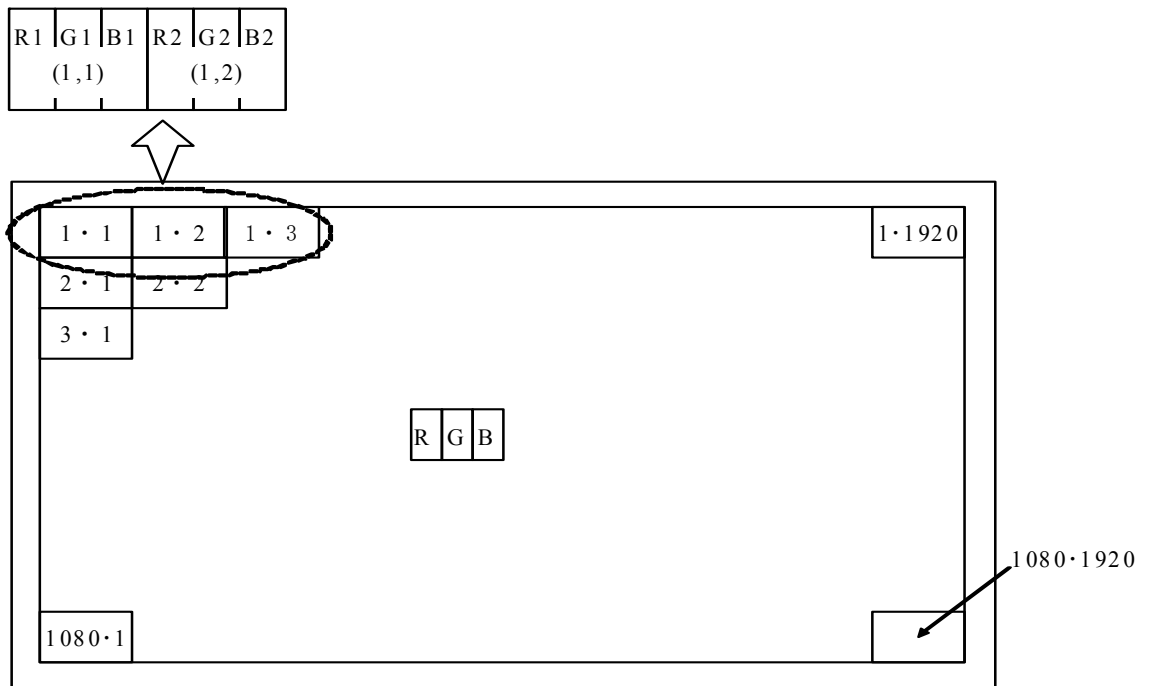

Display position of input data(V · H)

8. Input Signals, Basic Display Colors and Gray Scale of Each Color

Colors & Gray Scale	Date signal																															
	Gray Scale	R0	R1	R2	R3	R4	R5	R6	R7	G0	G1	G2	G3	G4	G5	G6	G7	B0	B1	B2	B3	B4	B5	B6	B7							
		LSB								MSB								LSB								MSB						
Basic Color	Black	—	0	0	0	0	0	0	0	0	0	0	0	0	0	0	0	0	0	0	0	0	0	0	0							
	Blue	—	0	0	0	0	0	0	0	0	0	0	0	0	0	0	0	0	1	1	1	1	1	1	1							
	Green	—	0	0	0	0	0	0	0	0	1	1	1	1	1	1	1	1	0	0	0	0	0	0	0							
	Cyan	—	0	0	0	0	0	0	0	0	1	1	1	1	1	1	1	1	1	1	1	1	1	1	1							
	Red	—	1	1	1	1	1	1	1	1	0	0	0	0	0	0	0	0	0	0	0	0	0	0	0							
	Magenta	—	1	1	1	1	1	1	1	1	0	0	0	0	0	0	0	0	1	1	1	1	1	1	1							
	Yellow	—	1	1	1	1	1	1	1	1	1	1	1	1	1	1	1	1	0	0	0	0	0	0	0							
	White	—	1	1	1	1	1	1	1	1	1	1	1	1	1	1	1	1	1	1	1	1	1	1	1							
Gray Scale of Red	Black	GS0	0	0	0	0	0	0	0	0	0	0	0	0	0	0	0	0	0	0	0	0	0	0								
	↑	GS1	1	0	0	0	0	0	0	0	0	0	0	0	0	0	0	0	0	0	0	0	0	0								
	Darker	GS2	0	1	0	0	0	0	0	0	0	0	0	0	0	0	0	0	0	0	0	0	0	0								
	↑	↓	↓								↓								↓													
	↓	↓	↓								↓								↓													
	Brighter	GS253	1	0	1	1	1	1	1	1	0	0	0	0	0	0	0	0	0	0	0	0	0	0	0							
	↓	GS254	0	1	1	1	1	1	1	1	0	0	0	0	0	0	0	0	0	0	0	0	0	0	0							
	Red	GS255	1	1	1	1	1	1	1	1	0	0	0	0	0	0	0	0	0	0	0	0	0	0	0							
Gray Scale of Green	Black	GS0	0	0	0	0	0	0	0	0	0	0	0	0	0	0	0	0	0	0	0	0	0	0								
	↑	GS1	0	0	0	0	0	0	0	0	1	0	0	0	0	0	0	0	0	0	0	0	0	0								
	Darker	GS2	0	0	0	0	0	0	0	0	0	1	0	0	0	0	0	0	0	0	0	0	0	0								
	↑	↓	↓								↓								↓													
	↓	↓	↓								↓								↓													
	Brighter	GS253	0	0	0	0	0	0	0	0	1	0	1	1	1	1	1	1	0	0	0	0	0	0	0							
	↓	GS254	0	0	0	0	0	0	0	0	0	1	1	1	1	1	1	1	0	0	0	0	0	0	0							
	Green	GS255	0	0	0	0	0	0	0	0	1	1	1	1	1	1	1	1	0	0	0	0	0	0	0							
Gray Scale of Blue	Black	GS0	0	0	0	0	0	0	0	0	0	0	0	0	0	0	0	0	0	0	0	0	0	0								
	↑	GS1	0	0	0	0	0	0	0	0	0	0	0	0	0	0	0	0	1	0	0	0	0	0								
	Darker	GS2	0	0	0	0	0	0	0	0	0	0	0	0	0	0	0	0	0	1	0	0	0	0								
	↑	↓	↓								↓								↓													
	↓	↓	↓								↓								↓													
	Brighter	GS253	0	0	0	0	0	0	0	0	0	0	0	0	0	0	0	0	1	0	1	1	1	1	1							
	↓	GS254	0	0	0	0	0	0	0	0	0	0	0	0	0	0	0	0	0	1	1	1	1	1	1							
	Blue	GS255	0	0	0	0	0	0	0	0	0	0	0	0	0	0	0	0	1	1	1	1	1	1	1							

0 : Low level voltage, 1 : High level voltage

Each basic color can be displayed in 256 gray scales from 8 bit data signals.

According to the combination of 24 bit data signals, the 16.7M color display can be achieved on the screen.

9. EDID Specifications

9 - 1. EDID data structure

This is the EDID(Extended Display Identification Data) data formats to support displays as defined in the VESA Plug & Display

Byte (decimal)	Byte (hex)	Field Name and Comments	Value (hex)	Value (binary)
0	00	Header	00	00000000
1	01	Header	FF	11111111
2	02	Header	FF	11111111
3	03	Header	FF	11111111
4	04	Header	FF	11111111
5	05	Header	FF	11111111
6	06	Header	FF	11111111
7	07	Header	00	00000000
8	08	EISA manufacture code = SHP	4D	01001101
9	09	EISA manufacture code (Compressed ASCII)	10	00010000
10	0A	Product code (LQ133M1JW07 : 5173)	35	00110101
11	0B	Product code (hex,LSB first)	14	00010100
12	0C	LCD module Serial No (fixed "0")	00	00000000
13	0D	LCD module Serial No (fixed "0")	00	00000000
14	0E	LCD module Serial No (fixed "0")	00	00000000
15	0F	LCD module Serial No (fixed "0")	00	00000000
16	10	Week of manufacture	2A	00101010
17	11	Year of manufacture - 1990 (ex 2000 - 1990 = 10)	18	00011000
18	12	EDID structure version # = 1	01	00000001
19	13	EDID revision # = 4	04	00000100
20	14	Video i/p definition = Digital 8bit DP support	A5	10100101
21	15	Max H image size(cm) = 29cm	1D	00011101
22	16	Max V image size(cm) = 17cm	11	00010001
23	17	Display gamma (2.2×100) - 100 = 120	78	01111000
24	18	Feature support(stanby,suspend,RGB color/Prefer Time)	06	00000110
25	19	Red/Green Low bit(RxRy/GxGy)	DE	11011110
26	1A	Blue/White Low bit(BxBY/WxWy)	50	01010000
27	1B	Red X(Rx) (written value 0.64)	A3	10100011
28	1C	Red Y(Ry) (written value 0.33)	54	01010100
29	1D	Green X(Gx) (written value 0.3)	4C	01001100
30	1E	Green Y(Gy) (written value 0.6)	99	10011001
31	1F	Blue X(Bx) (written value 0.15)	26	00100110
32	20	Blue Y(By) (written value 0.06)	0F	00001111
33	21	White X(Wx) (written value 0.313)	50	01010000
34	22	White Y(Wy) (written value 0.329)	54	01010100
35	23	Established timings 1	00	00000000
36	24	Established timings 2	00	00000000
37	25	Established timings 3(Manufacture's reserved timing)	00	00000000
38	26	Standard timing ID1	01	00000001
39	27	Standard timing ID1	01	00000001
40	28	Standard timing ID2	01	00000001
41	29	Standard timing ID2	01	00000001
42	2A	Standard timing ID3	01	00000001
43	2B	Standard timing ID3	01	00000001

44	2C	Standard timing ID4	01	00000001
45	2D	Standard timing ID4	01	00000001
46	2E	Standard timing ID5	01	00000001
47	2F	Standard timing ID5	01	00000001
48	30	Standard timing ID6	01	00000001
49	31	Standard timing ID6	01	00000001
50	32	Standard timing ID7	01	00000001
51	33	Standard timing ID7	01	00000001
52	34	Standard timing ID8	01	00000001
53	35	Standard timing ID8	01	00000001
54	36	Detailed timing descriptor#1 fck/10000 (=138.5MHz/10000=13850=361Ah)	1A	00011010
55	37	#1 fck	36	00110110
56	38	#1 Horizontal active 1920=780h 80h	80	10000000
57	39	#1 Horizontal blanking 160=0A0h A0h	A0	10100000
58	3A	#1 Horizontal active/Horizontal blanking 70h	70	01110000
59	3B	#1 Vertical active 1080=438h 38h	38	00111000
60	3C	#1 Vertical blanking 31=01Fh 1Fh	1F	00011111
61	3D	#1 Vertical active/Vertical blanking 40h	40	01000000
62	3E	#1 Horizontal sync , offset(Thfp) 48=030h 30h	30	00110000
63	3F	#1 Horizontal sync , width 32=020h 20h	20	00100000
64	40	#1 Vertical sync,offset / Vertical sync,width (offset=3h/width=5h)	35	00110101
65	41	#1 Horizontal sync offset/width/Vertical sync offset/width	00	00000000
66	42	#1 Horizontal image size 293.76mm=126h 26h	26	00100110
67	43	#1 Vertical image size 165mm=0A5h A5h	A5	10100101
68	44	#1 Horizontal image size / Vertical image size 10h	10	00010000
69	45	Horizontal boader	00	00000000
70	46	Vertical boader	00	00000000
71	47	Flags(Non-interlaced=0/non 3D=00/Degital separate=11/Horizontal polarity/Vertical polarity=00)	18	00011000
72	48	Detailed timing descriptor#1 fck/10000 (=110.92224MHz/10000=11092.224=2B54h)	54	01010100
73	49	#2 fck	2B	00101011
74	4A	#2 Horizontal active 1920=780h 80h	80	10000000
75	4B	#2 Horizontal blanking 160=0A0h A0h	A0	10100000
76	4C	#2 Horizontal active/Horizontal blanking 70h	70	01110000
77	4D	#2 Vertical active 1080=438h 38h	38	00111000
78	4E	#2 Vertical blanking 31=01Fh 1Fh	1F	00011111
79	4F	#2 Vertical active/Vertical blanking 40h	40	01000000
80	50	#2 Horizontal sync , offset(Thfp) 48=030h 30h	30	00110000
81	51	#2 Horizontal sync , width 32=020h 20h	20	00100000
82	52	#2 Vertical sync,offset / Vertical sync,width (offset=3h/width=5h)	35	00110101
83	53	#2 Horizontal sync offset/width/Vertical sync offset/width	00	00000000
84	54	#2 Horizontal image size 293.76mm=126h 26h	26	00100110
85	55	#2 Vertical image size 165mm=0A5h A5h	A5	10100101
86	56	#2 Horizontal image size / Vertical image size 10h	10	00010000
87	57	Horizontal boader	00	00000000
88	58	Vertical boader	00	00000000
89	59	Flags(Non-interlaced=0/non 3D=00/Degital separate=11/Horizontal polarity/Vertical polarity=00)	18	00011000
90	5A	Detailed timing descriptor #3	00	00000000
91	5B	Flag	00	00000000

92	5C	Reserved	00	00000000
93	5D	Dummy Descriptor	10	00010000
94	5E	Flag	00	00000000
95	5F	1st Dummy	00	00000000
96	60	2nd Dummy	00	00000000
97	61	3rd Dummy	00	00000000
98	62	4th Dummy	00	00000000
99	63	5th Dummy	00	00000000
100	64	6th Dummy	00	00000000
101	65	7th Dummy	00	00000000
102	66	8th Dummy	00	00000000
103	67	9th Dummy	00	00000000
104	68	10th Dummy	00	00000000
105	69	11th Dummy	00	00000000
106	6A	New line character #3 indicates end	00	00000000
107	6B	Padding with "blank" character	00	00000000
108	6C	Detailed timing descriptor #4	00	00000000
109	6D	Flag	00	00000000
110	6E	Reserved	00	00000000
111	6F	Display Product name	FC	11111100
112	70	Flag	00	00000000
113	71	Supplier P/N#1 (L)	4C	01001100
114	72	Supplier P/N#2 (Q)	51	01010001
115	73	Supplier P/N#3 (1)	31	00110001
116	74	Supplier P/N#4 (3)	33	00110011
117	75	Supplier P/N#5 (3)	33	00110011
118	76	Supplier P/N#6 (M)	4D	01001101
119	77	Supplier P/N#7 (1)	31	00110001
120	78	Supplier P/N#8 (J)	4A	01001010
121	79	Supplier P/N#9 (W)	57	01010111
122	7A	Supplier P/N#10 (0)	30	00110000
123	7B	Supplier P/N#11 (7)	37	00110111
124	7C	Supplier P/N#12 ("Space")	0A	00001010
125	7D	(If<13 char,then terminate with ASCII code 0Ah,set remaining char 20h)	20	00100000
126	7E	Extension flag	00	00000000
127	7F	Checksum	D8	11011000

10. Optical Characteristics

Ta=+25°C, VDD=+3.3V, I_F=19.8mA

Parameter		Symbol	Condition	Min.	Typ.	Max.	Unit	Remark
Viewing angle range	Horizontal	θ_{21}, θ_{22}	CR>10	80	89	—	deg.	[Note 10-1, 10-3, 10-4, 10-6]
	Vertical	θ_{11}		80	89	—	deg.	
		θ_{12}		80	89	—	deg.	
Contrast ratio		CR	$\theta = 0^\circ$	700	1000	—		[Note 10-2, 10-4, 10-6]
Response time		$\tau_r + \tau_d$	$\theta = 0^\circ$	—	25	—	ms	[Note 10-1, 10-5, 10-6]
Chromaticity of white		x		0.283	0.313	0.343		[Note 10-2, 10-6] Normal operation (PWM Duty=100%)
		y		0.299	0.329	0.359		
Chromaticity of red		x		—	0.640	—		
		y		—	0.330	—		
Chromaticity of green		x		—	0.300	—		
		y		—	0.600	—		
Chromaticity of blue		x		—	0.150	—		
		y		—	0.060	—		
NTSC ratio		%		—	72	—		
Luminance of white		Y _{LI}	—	240	300	—	cd/m ²	
White uniformity		δ_w	$\theta = 0^\circ$	—	1.25	1.40		[Note 10-2, 10-7]

※ The measurement shall be taken 30 minutes after lighting the module at the following rating.

Condition: PWM Duty = 100%

The optical characteristics shall be measured in a dark room or equivalent.

[Note 10-1] Measurement of viewing angle range and Response time.

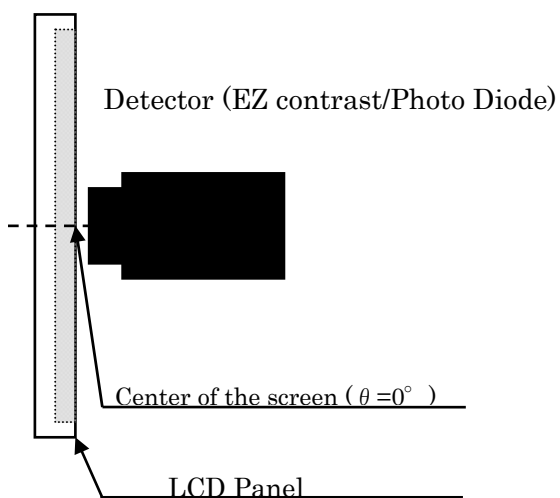

[Note 10-2] Measurement of luminance and Chromaticity and Contrast.

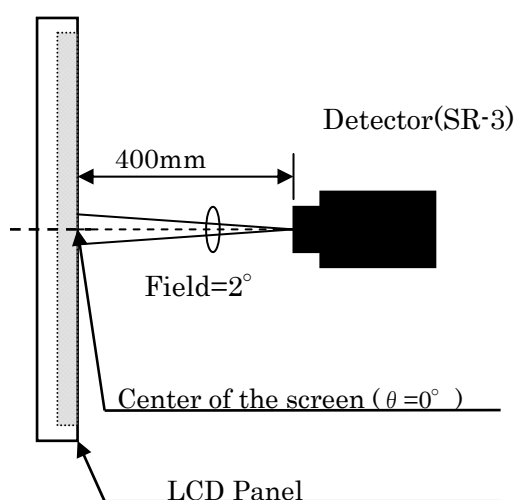

- Viewing angle range: EZ-CONTRAST
- Response time: Photo diode

[Note 10-3] Definitions of viewing angle range:

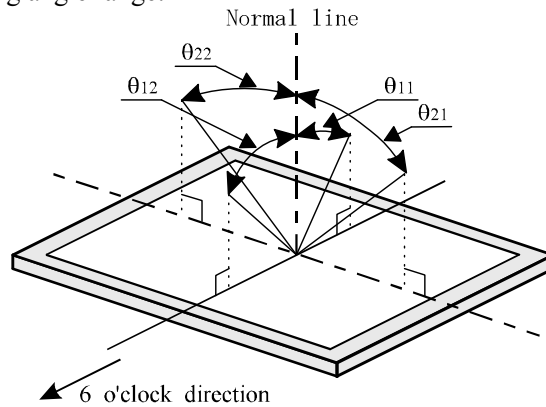

[Note 10-4] Definition of contrast ratio:

The contrast ratio is defined as the following.

$$\text{Contrast Ratio (CR)} = \frac{\text{Luminance (brightness) with all pixels white}}{\text{Luminance (brightness) with all pixels black}}$$

[Note 10-5] Definition of response time:

The response time is defined as the following figure and shall be measured by switching the input signal for "black" and "white" .

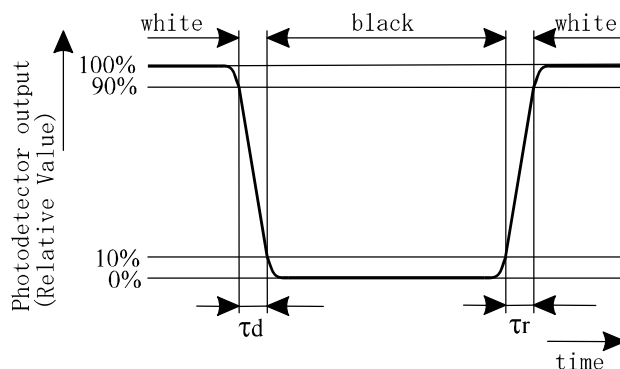

[Note 10-6] This shall be measured at center of the screen.

[Note 10-7] Definition of white uniformity:

White uniformity is defined as the following with five measurements (A~E).

$$\delta w = \frac{\text{Maximum Luminance of five points (brightness)}}{\text{Minimum Luminance of five points (brightness)}}$$

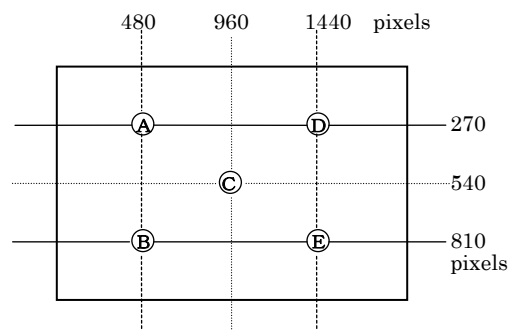

11. Display Quality

The display quality of the color TFT-LCD module shall be in compliance with the Incoming Inspection Standard.

12. Handling Precautions

- a) Be sure to turn off the power supply when inserting or disconnecting the cable.
Please insert for too much stress not to join a connector in the case of insertion of a connector.
- b) Be sure to design the cabinet so that the module can be installed without any extra stress such as warp or twist.
- c) Since the front polarizer is easily damaged, pay attention not to scratch it.
- d) Wipe off water drop immediately. Long contact with water may cause discoloration or spots.
- e) When the panel surface is soiled, wipe it with absorbent cotton or other soft cloth.
- f) Since the panel is made of glass, it may break or crack if dropped or bumped on hard surface. Handle with care.
- g) Since CMOS LSI is used in this module, take care of static electricity and injure the human earth when handling. Observe all other precautionary requirements in handling components.
- h) This module has its circuitry PCBs on the side and should be handled carefully in order not to be stressed.
- i) Laminate film is attached to the module surface to prevent it from being scratched. Peel the laminate film off slowly just before the use with strict attention to electrostatic charges. Ionized air shall be blown over during the action. Blow off the 'dust' on the polarizer by using an ionized nitrogen gun, etc. Working under the following environments is desirable.
 - All workers wear conductive shoes, conductive clothes, conductive fingerstalls and grounding belts without fail.
 - When you peel off the protection film,
 - Be sure to peel off slowly (recommended more than 5sec) and constant speed.
 - Peeling direction shows the following Figure.
 - Be sure to ground person with adequate methods such as the anti-static wrist band.
 - Be sure to ground all terminals of the PWB connector while peeling of the protection film.
 - Ionized air should be blown over during peeling action.
 - The protection film must not touch driver-ICs, PWB and all components on PWB.
 - If adhesive may remain on the polarizer after the protection film peeling off, please remove with isopropyl-alcohol.

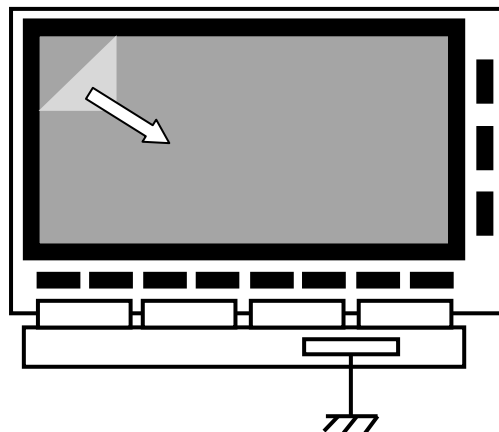

- j) The polarizer surface on the panel is treated with Anti Glare . In case of attaching protective board over the LCD, be careful about the optical interface fringe etc. which degrades display quality.
- k) Do not expose the LCD module to a direct sunlight, for a long period of time to protect the module from the ultra violet ray.
- l) When handling LCD modules and assembling them into cabinets, please be noted that long-term storage in the environment of oxidization or deoxidization gas and the use of such materials as reagent, solvent, adhesive, resin, etc. which generate these gasses, may cause corrosion and discoloration of the LCD modules.

- m) Liquid crystal contained in the panel may leak if the LCD is broken. Rinse it as soon as possible if it gets inside your eye or mouth by mistake.
- n) Disassembling the module can cause permanent damage and should be strictly avoided.
Please don't remove the fixed tape, insulating tape etc that was pasted on the original module.
(Except for protection film of the panel.)
- o) Be careful when using it for long time with fixed pattern display as it may cause afterimage.
(Please use a screen saver etc., in order to avoid an afterimage.)
- p) If a minute particle enters in the module and adheres to an optical material, it may cause display non-uniformity issue, etc. Therefore, fine-pitch filters have to be installed to cooling and inhalation hole if you intend to install a fan.
- q) Epoxy resin (amine series curing agent), silicone adhesive material (dealcoholization series and oxime series),
tray forming agent (azo compound) etc, in the cabinet or the packing materials may induce abnormal display with polarizer film deterioration regardless of contact or noncontact to polarizer film.
Be sure to confirm the component of them.
- r) Do not use polychloroprene. If you use it, there is some possibility of generating Cl₂ gas that influences the reliability of the connection between LCD panel and driver IC.
- s) Do not put a laminate film on LCD module, after peeling of the original one. If you put on it, it may cause discoloration or spots because of the occurrence of air gaps between the polarizer and the film.
- t) Ground module bezel to stabilize against EMI and external noise.

13. Precautions for Handling Tray

- a) Hold center of short side of tray with both hands when handling one or more trays.

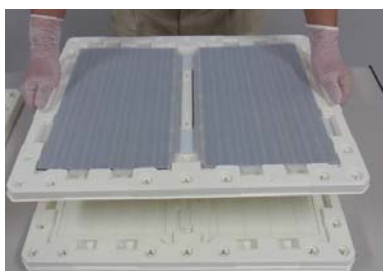

Caution : Do not handle with only one hand .



- b) Always place tray on flat surface
- c) When stacking trays, please align same shape corner of each tray.
One corner is R corner. (Ref. Pic.1)

d) Maximum stacking quantity is the number of trays inside one box.

Ex. : In case of 30pcs LCD module per box (2pcs LCD module per tray), maximum stacking is 15 trays.

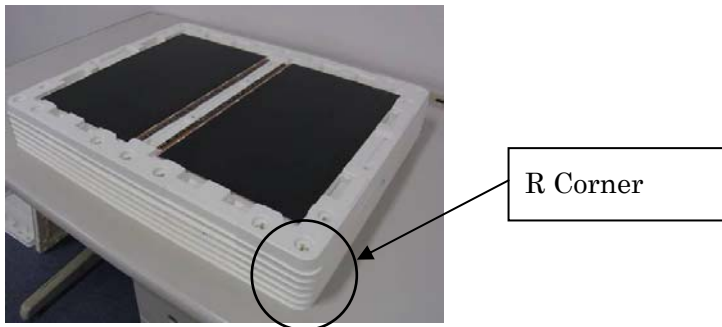

Pic.1 Stacking tray

14. Packaging Condition

Piling number of cartons	8
Package quantity in one carton	30pcs
Carton size	544*434*210mm
Total mass of one carton filled with full modules	13.3kg
Packing form	Fig.1

15. Label

1) Module Bar code label:

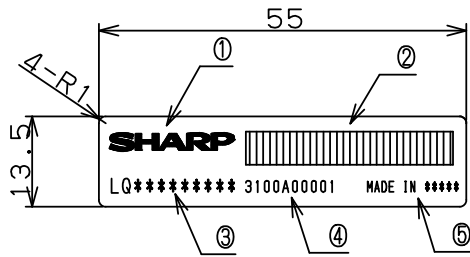

Label

	size	notes
①:SHARP logo	(3.0)	data:sharplogo
②:Bar Code (Serial Number)	-	
③:SHARP Model Number	(2.5)	
④:Serial Number	(2.0)	
⑤:Manufacturing site	(1.8)	

④:Serial Number

10digits

※There is no space between characters

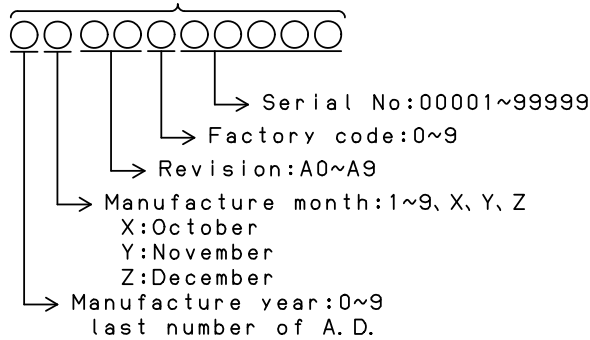

Factory code
⑤:Manufacturing site

No.	Factory code	Manufacturing site
0	W-TECH	CHINA
1	*****	*****
2	*****	*****
3	*****	*****

2) Packing bar code label

社内品番: (4S) LQ*****

LotNO.: (1T) 2014. xx. xx

Quantity: (Q) 30 PCS

ユーザー品番 :

シャープ物流用ラベルです。

16. RoHS Directive

This LCD module is compliant with RoHS Directive.

17. Reliability Test Items

No.	Test item	Conditions
1	High temperature storage test	Ta = 60°C 240h
2	Low temperature storage test	Ta = -20°C 240h
3	High temperature & high humidity operation test	Ta = 40°C ; 90%RH 240h (No condensation)
4	High temperature operation test	Ta = 50°C 240h
5	Low temperature operation test	Ta = 0°C 240h
6	Vibration test (non- operating)	Acceleration: 1.5G, ±X,Y,Z axis condition, 30minutes each axis. Frequency: 10~500Hz Random
7	Shock test (non- operating)	Acceleration: 220 G , Half sine wave, ±X, Y, Z axis condition (6 surfaces). Active time: 2 ms
8	ESD	Condition1 ±200V, 200pF(0Ω) 1time/each terminal Condition2 Based on IEC61000-4-2 (Operation test) Contact discharge : ±6kV (Without restore apparatus function) ±8kV (With restore apparatus function) Air discharge : ±10kV (Without restore apparatus function) ±15kV (With restore apparatus function)
9	Thermal shock	-20°C(30min)~60°C(30min), 20cycles

[Result Evaluation Criteria] Under the display quality test conditions with normal operation state.

Do not change these conditions as such changes may affect practical display function.

[Normal operation state] Temperature : +15~+35°C, Humidity : 45~75%, Atmospheric pressure : 86 ~106kPa

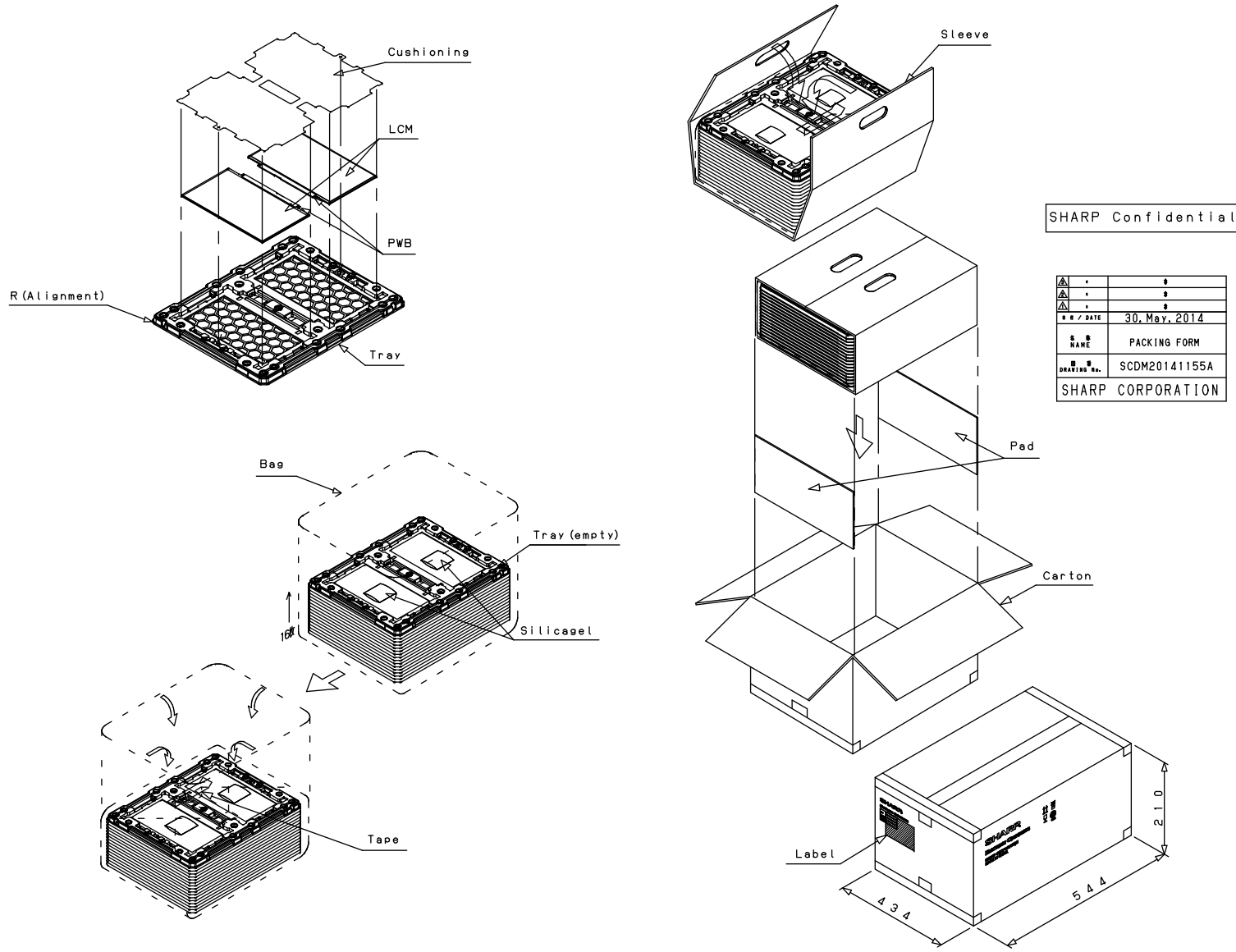
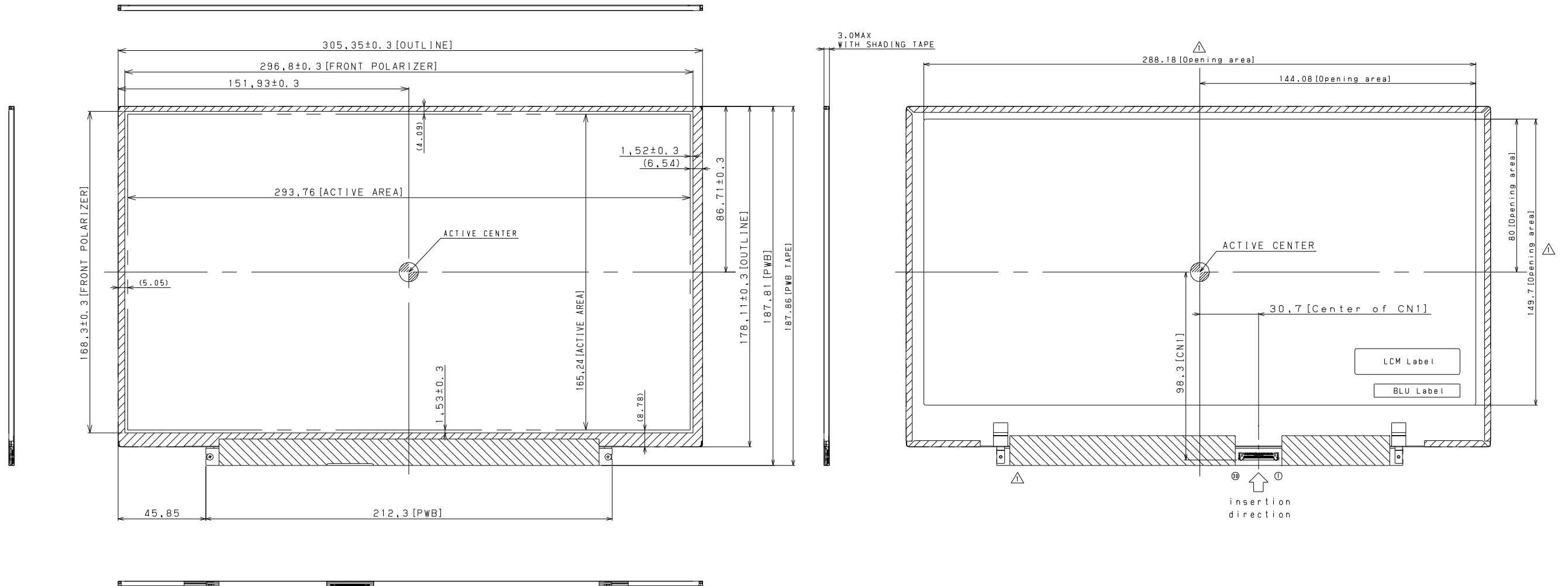

Fig. 1 Packing Condition

SHARP Confidential



Note

1. Unspecified tolerance to be 0.5.
2. Without warpage and deflection.
3. [H] means Module thickness from Front Polarizer surface to pertinent part.

△	*	*
△	*	*
△	5/20	ベゼル開口、PWB保護テープ寸法変更
日 付 / DATE	10, MAY, 2014	
名 称 NAME	13.3FHD OUTLINE	
図 番 DRAWING No.	SCDM20141153B	
SHARP CORPORATION		

Fig. 2 Outline Dimensions